

# **UPort™ 400A Series Quick Installation Guide**

---

**Version 1.0, November 2022**

**Technical Support Contact Information**  
[www.moxa.com/support](http://www.moxa.com/support)

**MOXA®**

© 2022 Moxa Inc. All rights reserved.

**P/N: 1802004002001**



## Overview

The UPort™ 400A Series Industrial-grade USB 3.2 Gen 1 hubs expand 1 USB port to 4 or 7 ports. The hubs are designed to provide true USB 3.2 SuperSpeed 5 Gbps data transmission through each port, even for heavy-load applications. As **USB-IF certified** products, the UPort™ 400A Series has passed SuperSpeed compliance testing and is eligible to bear the USB logo. Besides providing ESD level 4 protection from static damage and surge protection level 3 for power input, the UPort™ 400A Series offers a power jack and terminal block dual power input solution for industrial environments.

The following models comprise the UPort™ 400A Series:

- UPort™ 404A** 4-port industrial-grade USB hub, standard temperature 0 to 60°C (32 to 140°F), adapter included
- UPort™ 407A** 7-port industrial-grade USB hub, standard temperature 0 to 60°C (32 to 140°F), adapter included
- UPort™ 404A-T** 4-port industrial grade USB hub, wide temperature -40 to 85°C (-40 to 185°F), adapter excluded
- UPort™ 407A-T** 7-port industrial grade USB hub, wide temperature -40 to 85°C (-40 to 185°F), adapter excluded

## Features

- SuperSpeed USB 3.2 Gen 1 for up to 5 Gbps USB transmission
- USB-IF certification (TID: 7623, 7624)
- Provides level 4 ESD protection and level 3 surge protection for power input
- USB cable with latch
- Comprehensive diagnostic LEDs
- Dual power input supply (power jack and terminal block)
- Rugged metal housing
- Side-mount DIN Rail and wall mountable

## Package Checklist

The UPort™ 400A Series package should contain the following items. If any of these items is missing or damaged, please contact Moxa for replacement.

- UPort 400A USB hub
- USB cable with latch: CBL-USB3-BA-G-120, 1.2 m, with hook and screw
- 100 to 240 VAC, 0 to 40°C (32 to 104°F) power adapter suitable for your region (excluding -T models)
- Wall-mounting kit: Wall-mounting kit for the bottom side of the UPort 400A with 2 plates (43 x 30 x 2 mm/1.69 x 1.18 x 0.08 in) and 6 screws (M3 x 5 mm)
- Quick installation guide (printed)
- Warranty card

### Optional Accessories (can be purchased separately)

- Standard USB cable (without latch): CBL-USB3-BA-BK-120, 1.2 m
- USB cable with latch: CBL-USB3-BA-G-120, 1.2 m
- WK-UP400A-BAK-BK: Wall-mounting kit for the back side of the UPort 400A with 2 plates (60 x 27 x 2 mm/2.36 x 1.06 x 0.08 in) and 6 screws (M3x5mm)
- DK-UP-42A: Side-mount DIN Rail (107 x 29 mm/4.21 x 1.14 in) with 4 screws.

**NOTE** The operating temperature of the power adapter in the box is from 0 to 40°C (32 to 104 °F). If your application is not in this range, please use a power adapter supplied by UL Listed External Power Supply (The power output meets ES1/SELV and LPS and rated 12-48 VDC, 4.75 A @ 12 VDC 1 A @ 48VDC minimum for the UPort 407A models, 2.8 A @ 12 VDC minimum for the UPort 404A models).

## Hardware

An example of the UPort™ 404A front panel:

### Front View

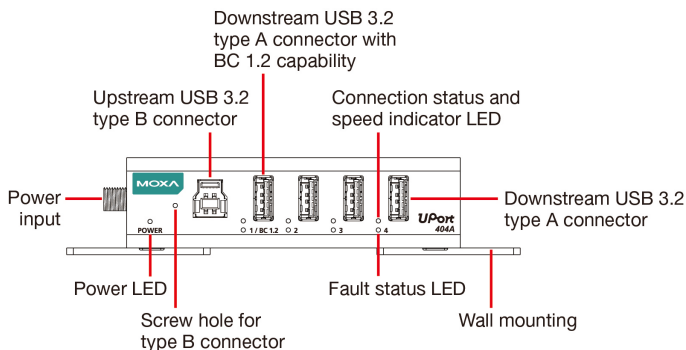

### Side View—Power Input 12 to 48 VDC

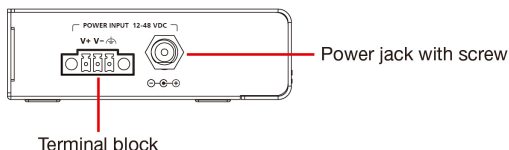

## Installation Guide

### Power Input Supply

The UPort 400A comes with self-power, minimum required 12-48 V input, 4.75 A @ 12 VDC, 1 A @ 48 VDC minimum for the UPort 407A models, 2.8 A @ 12 VDC minimum for the UPort 404A models.

## How to have Moxa's USB cable plugged into the hub and computer securely

The Moxa new latch USB cable comes with a latch on each side of the Type-A connector and a screw on the Type-B connector.

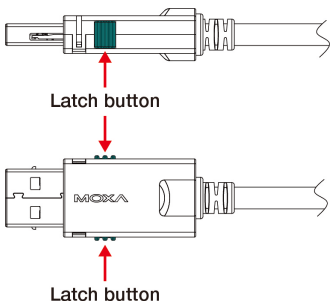

Every time you plug in and plug out the cable from the host computer, always press both latches and then plug the connector into the USB sockets on your computer or vice versa.

### Plugging in the cable to the host computer:

Step 1: Press both latches.

Step 2: Plug in.

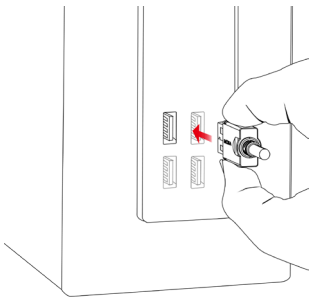
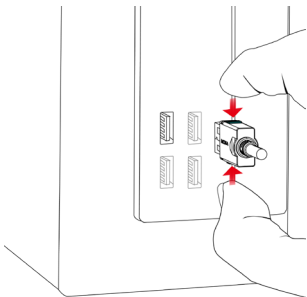

### Plugging out the cable from the host computer:

Step 1: Press both latches.

Step 2: Plug out.

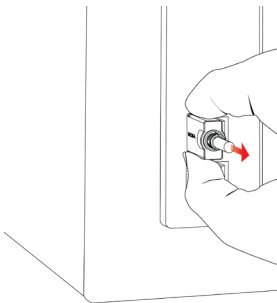
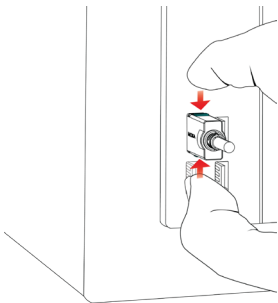

**NOTE** The latch is designed to lock to most of the computer USB sockets; however, some sockets may be designed with a slight margin difference, which may cause the latch not to lock to properly to those USB sockets.

### Plugging in the USB cable to the UPort 400A hub:

The bolt on the side of Type-B connector is for fixing the cable firmly to the UPort 400A USB hub. Remember to swivel the bolt after plugging in and before pulling out the connector.

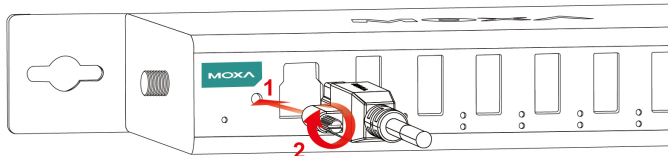

**Step 1:** Plug the USB cable type-B plug into the type-B socket.

**Step 2:** Turn the bolt on the type-B plug clockwise for about 5 turns.

### Plugging out the USB cable from the UPort 400A hub:

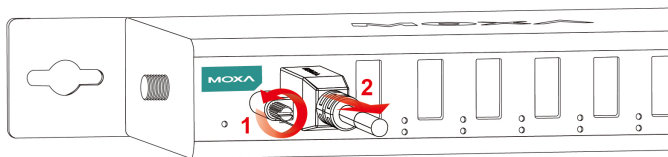

**Step 1:** Turn the bolt on the type-B plug anti-clockwise until the bolt is loose.

**Step 2:** Pull out the USB cable type-B plug from the type-B socket.

## LED Indicators

The LED indicators on the front panel are used to display status as follows:

Type	Color	Definition
Power	Green	Power on
	Off	Unit is not powered or out of operation
Status	Blue	Downstream USB device is recognized and connected with SuperSpeed
	Green	Downstream USB device is recognized and connected with high speed or full speed
	Off	Device not connected or out of operation
Fault	Red	Device over current is detected

## Wall Mounting

The UPort™ 400A Series comes with two options of wall mounting, and both have metal attachment plates to allow installation on a wall.

### Option 1 – Bottom-mounting with WK-UP400A-BOT-BK

#### UPort™ 407A

Unit: mm (inches)

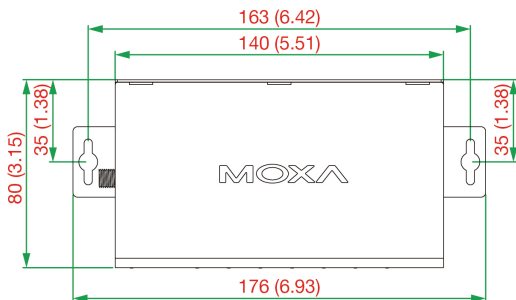

#### UPort™ 404A

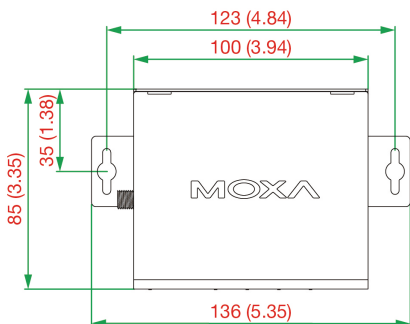

The mounting kit is 2 mm in height, and the two centers of the mounting kit on each plate is 163 mm (UPort 407A) and 123 mm (UPort 404A) apart.

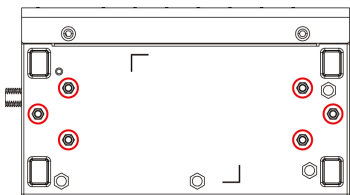

First, attach the brackets at the bottom of the UPort™ 400A with the screws, as the circles indicate. The recommended screw tightening torque: 4.5 kgf-cm +/- 0.5, screw type: type F, PH2. Next, mount the unit to a wall with the screws.

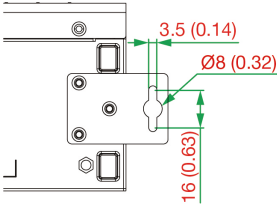

The wall screws should use the M3 type, and the length should no less than 7 mm.

### Option 2 – Rear-mounting With WK-UP400A-BAK-BK

#### UPort™ 407A

Unit: mm (inches)

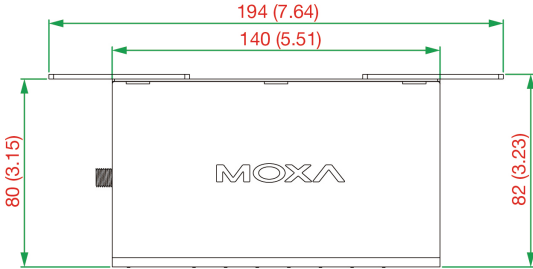

#### UPort™ 404A

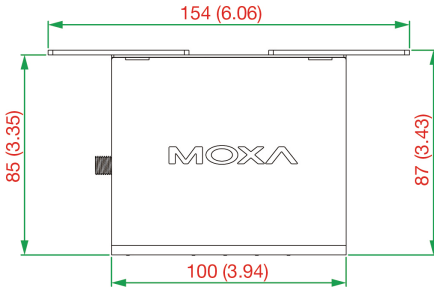

First, attach the brackets at the rear of the UPort™ 400A with the screws, as the circles indicate.



The recommended screw tightening torque: 4.5 kgf-cm +/- 0.5, screw type: type F, PH2. Next, mount the unit to a wall with the screws.

The wall screws should use the M3 type, and the length should no less than 7 mm.

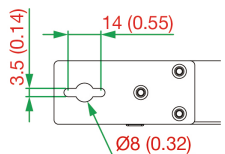

The mounting kit is 2 mm in height, and the two centers of mounting kit on each plate is 168 mm (for UPort 407A) and 128 mm (for UPort 404A) apart.

## **UPort™ 407A**

Unit: mm (inches)

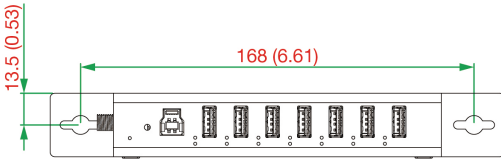

## **UPort™ 404A**

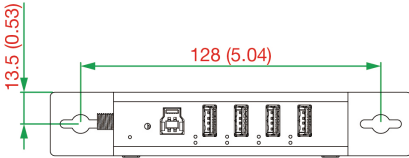

## **DIN-Rail Mounting**

The UPort™ 400A Series has a DIN-rail kit option (DK-UP-42A) to allow installation on a DIN Rail. DIN-rail attachments can be purchased separately to attach the product to a DIN Rail. The DIN-rail attachments should be oriented with the metal springs on top.

First, attach the DIN-rail attachments to the rear of the UPort™ 400A with screws, indicated by the circles. The recommended screw tightening torque: 4.5 kgf-cm +/- 0.5, screw type: type F, PH2.

### **UPort™ 407A**

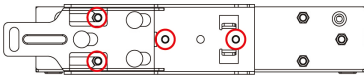

### **UPort™ 404A**

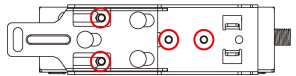

Next, mount the UPort™ 400A onto the mounting rail.

**STEP 1:** Insert the upper lip of the DIN-rail kit into the mounting rail.

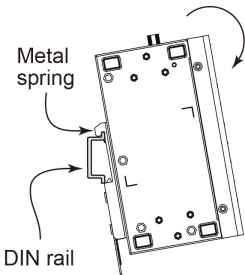

**STEP 2:** Press the UPort™ 400A towards the mounting rail until it snaps into place.

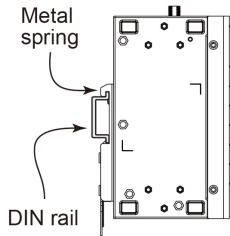



To remove the UPort™ 400A from the DIN Rail, do the following:

**STEP 1:**

Pull down the latch on the DIN-rail kit with a screwdriver.

**STEP 2 & 3:**

Slightly pull the UPort™ 400A forward and lift it up to remove it from the mounting rail.

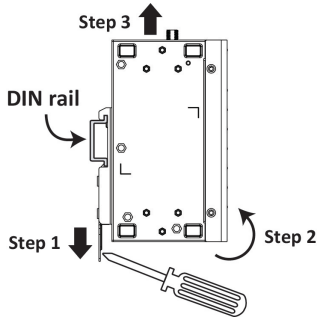

## Dimensions

### UPort™ 407A

Unit: mm (inch)

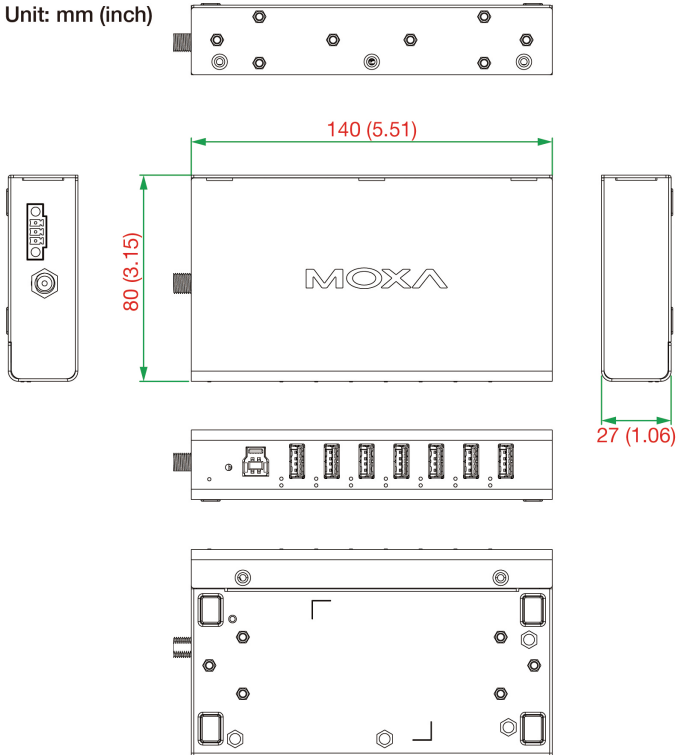

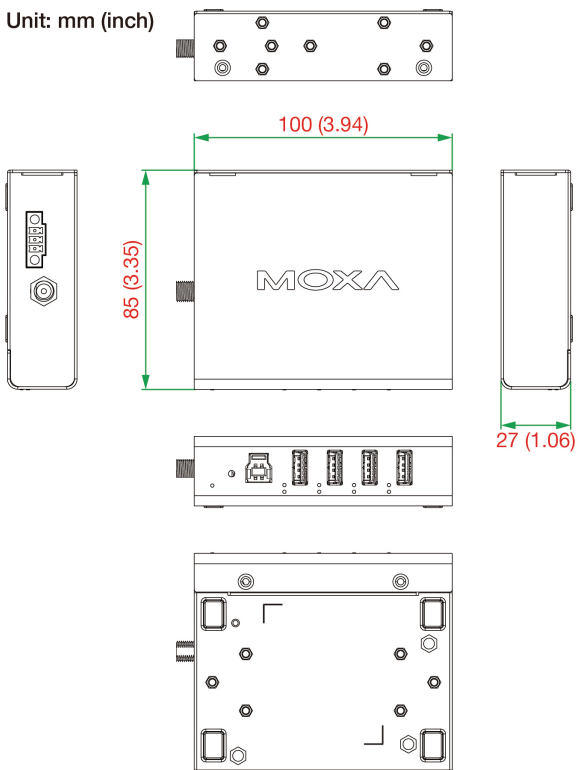

## UPort™ 404A

Unit: mm (inch)



## Specification

USB Interface	
Compliance	USB 3.2/2.0/1.1, BC 1.2 compliant
Upstream	1 USB Type-B port
Downstream	UPort™ 404A: 4 USB Type-A ports UPort™ 407A: 7 USB Type-A ports
Speed	5 Gbps (SuperSpeed USB), 480 Mbps (Hi-speed USB) and 12 Mbps (Full-speed USB)
Physical Characteristics	
Housing	Aluminum
Dimensions	UPort™ 404A/404A-T: 85 x 27 x 100 mm (3.35 x 1.06 x 3.94 in) UPort™ 407A/407A-T: 80 x 27 x 140 mm (3.15 x 1.06 x 5.51 in)
Environmental Limits	
Operating Temperature	Standard Models: 0 to 60°C (32 to 140°F) Wide Temp. Models: -40 to 85°C (-40 to 185°F)
Operating Humidity	5 to 95% RH (For use in Pollution Degree 2 environments)
Storage Temperature	Standard Models: -20 to 75°C (-4 to 167°F) Wide Temp. Models: -40 to 85°C (-40 to 185°F)

<b>Power Requirements</b>	
Input Voltage	12 to 48 VDC (external power)
DC Power/Polarity	<p>V+ V- </p> 
Power Consumption	UPort™ 404A: 2800 mA @ 12 VDC, 1400 mA @ 24 VDC, 700 mA @ 48 VDC UPort™ 407A: 4750 mA @ 12 VDC, 2375 mA @ 24 VDC, 1187 mA @ 48 VDC
<b>Warranty</b>	
Warranty Period	5 years
Details	See <a href="http://www.moxa.com/warranty">www.moxa.com/warranty</a>

## Compliance Notice



### CE Warning

This is a Class A product. In a domestic environment, this product may cause radio interference in which case the user may be required to take appropriate measures.

## Federal Communications Commission Statement

FCC - This device complies with part 15 of the FCC Rules. Operation is subject to the following two conditions: (1) This device may not cause harmful interference, and (2) this device must accept any interference received, including interference that may cause undesired operation.



### FCC Warning

This equipment has been tested and found to comply with the limits for a Class A digital device, pursuant to part 15 of the FCC Rules. These limits are designed to provide reasonable protection against harmful interference when the equipment is operated in a commercial environment. This equipment generates, uses, and can radiate radio frequency energy and, if not installed and used in accordance with the instruction manual, may cause harmful interference to radio communications. Operation of this equipment in a residential area is likely to cause harmful interference in which case the user will be required to correct the interference at his own expense.

## Connector Description

### Power Connector

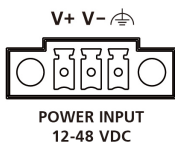

- The wiring of input terminal block must be installed by a skilled person.
- Wire type: Cu
- Only use 12-28 AWG wire size, torque value 0.18 N-m.
- One individual conductor in a clamping point. If you are using a Class I adapter, the power cord must be connected to an outlet with an earthing connection.

### 사용자안내문 (User Guide)

이 기기는 업무용 환경에서 사용할 목적으로 적합성평가를 받은 기기로서 가정용 환경에서 사용하는 경우 전파간섭의 우려가 있습니다.

(This equipment has KC approval for use in industrial environments and could possibly interfere with household equipment.)

기 종별 Type of Equipment	사용자안내문 User Guide
<p>A 급 기기 (업무용 방송 통신기 자재)</p> <p>Class A Equipment (Broadcasting and Communication Equipment for Industrial and Commercial Use)</p>	<p>이 기기는 업무용 (A 급) 전자파 적합 기기로서 판매자 또는 사용자는 이 점을 주의하시기 바라며 가정 외의 지역에서 사용하는 것을 목적으로 합니다.</p> <p>This equipment is the EMC conformity equipment (Class A) for Industrial and Commercial Use. The seller or user should take note of this as this equipment can be used in places that exclude homes.</p>
<p>B 급 기기 (가정용 방송 통신기자재)</p> <p>Class B Equipment (Broadcasting and Communication Equipment for Home Use)</p>	<p>이 기기는 가정용 (B 급) 전자파적합 기기로서 주로 가정에서 사용하는 것을 목적으로 하며, 모든 지역에서 사용할 수 있습니다.</p> <p>This equipment is the EMC conformity equipment (Class B) for Home Use and can be used mainly at homes, as well as in other areas.</p>

## FAQ

### Q: Does the UPort™ 400A require a software driver?

A: UPort™ 400A is USB-IF certified; it works with major operation systems and does not require an additional driver.

**Q: My device is USB 2.0 compatible. Will the UPort 400A work with my device?**

A: The UPort 400A is a USB 3.2 Gen 1 certified product; therefore, it is downward compatible to USB 2.0 and 1.1.

**Q: How many USB device cascade can the UPort 400A support?**

A: Five layers. By definition, the USB-IF should have seven layers of USB device cascading. The host computer and the UPort 400A have each taken one layer already; therefore, five layers remain available for cascading. There are some cases where the host computer design may take more than one layer and so the availability of the cascading layers may vary.

**Q: When I plug my USB device into the UPort 400A, why cannot it be detected by the host computer or recognized as an USB 2.0 device?**

A: The UPort 400A is USB-IF certified (USB-IF TID: 7623 for UPort 407A, 7624 for UPort 404A); however, interoperability issues can still arise among devices made by different manufacturers. The chance of this happening is higher if your USB device is not USB-IF certified as over/under SPEC design.

1. Please ensure the UPort 400A is recognized by the host computer first.
2. Plug your device to different USB port on the hub to rule out USB port being damaged.
3. Please check if it is a cable-related issue; change to a different cable to rule out a broken cable issue.
4. Unplug the USB device or restart the device in computer management like Windows Driver Manager.

**Q: What is the output power of each port?**

A: Port 1 provides 1.5 A if your USB device supports BC 1.2; otherwise, each port provides 0.9 A power.

**Q: What is BC 1.2 shown on port 1? What does it do?**

A: BC 1.2 AKA Battery Charging v1.2, defined by USB-IF, is designed to charge mobile devices and support up to 1.5 A if the mobile device supports CDP or DCP mode.

**Q: If overcurrent happens, what should I do?**

A: When overcurrent protection LED is on, it means the downstream device is drawing power over the USB port's limit. Please remove the downstream USB device from the UPort 400A and unplug the upstream USB cable or power source. The UPort 400A should return to normal state. Please check your downstream USB device to make sure it is not malfunctioning, and the design is within USB-IF specification, and re-plug in to the UPort 400A.