



(Terminal Type)



(Wiring Type)



## Features

- Power or charger mode switchable by SBP-001(Terminal type)
- High efficiency up to 96%
- Aluminum case fanless design and filling with heat-conducted glue and able to withstand 10G vibration test
- Wide operating temperature range -40 ~ +70°C
- Charger for lead-acid batteries (flooded, Gel and AGM) and Li-ion batteries (lithium iron and lithium manganese)
- Built-in default 2/3 stage charging curves and programmable curve
- Built-in PMBus protocol / CANBus protocol (optional)
- Output voltage and constant current level programmable
- Protections: Short circuit / Overload / Over voltage / Over temperature
- Built-in remote ON-OFF control (Terminal type)
- DC OK active signal and 12V Auxiliary power available
- LED indicator for power on (Terminal type)
- IP67 design for indoor or outdoor installation (Wiring type)
- 6 years warranty

## Applications

- Industrial automation machinery
- Industrial control system at harsh environment
- Mechanical and electrical equipment
- Electronic instruments, equipments
- 5G telecom equipments
- Robotic lawn mower/AMR/AGV
- Equipments or instruments with back-up battery

## Description

HEP-1000 is a 1000W industrial AC/DC power supply featuring the outstanding capability to operate under highly humid, dusty, oily, and high-vibration harsh environment. The entire series is housed with the aluminum case and fully potted with heat-conducted glue. Adopting the full range 90~305VAC input, the entire series provides an output voltage line of 24V, 48V and 100V. In addition to the high efficiency up to 96%, that the whole series operates from -40°C ~ 70°C under air convection without fan. HEP-1000 has the complete protection functions and 10G anti-vibration capability ; It is complied with the international safety regulations such as TUV BS EN/EN62368-1 UL62368-1, and the design refers to BS EN/EN61558-1 and BS EN/EN60335-1HEP-1000 series serves as a high performance power supply solution for various industrial and charger applications.

## Model Encoding

HEP - 1000 - 24 W

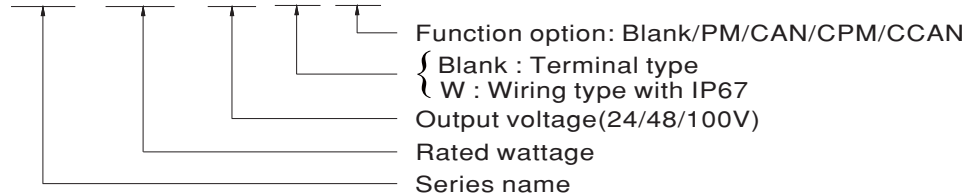

I/O Type	Function type	Communication Protocol	Note
Terminal	Blank	PMBus and PV/PC programmable	In Stock
	CAN	CANBus and PV/PC programmable	By request
Wiring	Blank	PV/PC programmable	By request
	PM	PMBus	By request
	CAN	CANBus	By request
	CPM	Charger with PMBus	By request
	CCAN	Charger with CANBus	By request

Note: Terminal type with charger function by programmer or PMBus/CANBus setting

**SPECIFICATION FOR POWER SUPPLY (Default Setting)**

MODEL	HEP-1000-24 <input type="checkbox"/> <input type="checkbox"/>		HEP-1000-48 <input type="checkbox"/> <input type="checkbox"/>		HEP-1000-100 <input type="checkbox"/> <input type="checkbox"/>		
OUTPUT	DC VOLTAGE	24V		48V		100V	
	RATED CURRENT	42A		21A		10A	
	RATED POWER	1008W		1008W		1000W	
	RIPPLE & NOISE (max.) Note.2	200mVp-p		250mVp-p		500mVp-p	
	VOLTAGE ADJ. RANGE	By built-in potentiometer, SVR					
		24 ~ 30V		48 ~ 60V		100 ~ 125V	
	VOLTAGE TOLERANCE Note.3	±1.0%		±1.0%		±1.0%	
	LINE REGULATION	±0.5%		±0.5%		±0.5%	
	LOAD REGULATION	±0.5%		±0.5%		±0.5%	
	SETUP, RISE TIME	1800ms, 80ms at full load		230VAC /115VAC			
HOLD UP TIME (Typ.)	16ms / 230VAC at 75% load		12ms / 230VAC at full load				
INPUT	VOLTAGE RANGE Note.4	90 ~ 305VAC		250 ~ 431VDC			
	FREQUENCY RANGE	47 ~ 63Hz					
	POWER FACTOR (Typ.)	PF>0.99/115VAC, PF>0.95/230VAC, PF>0.93/277VAC at full load					
	EFFICIENCY (Typ.)	95%		96%		96%	
	AC CURRENT (Typ.)	10.1A / 115VAC	5.3A / 230VAC		4.5A / 277VAC		
	INRUSH CURRENT(Typ.)	Cold start 40A at 230VAC					
	LEAKAGE CURRENT	<0.75mA / 240VAC					
PROTECTION	OVERLOAD	105~125% rated current Protection type : Constant current limiting, shut down O/P voltage after 5 sec. After O/P voltage falls, re-power on to recover					
	SHORT CIRCUIT	Constant current limiting, unit will shutdown after 5 sec, re-power on to recover					
	OVER VOLTAGE	30 ~ 35V		60 ~ 70V		125 ~ 145V	
		Protection type :Shut down O/P voltage,re-power on to recover					
	OVER TEMPERATURE	Protection type :Shut down O/P voltage, recovers automatically after temperature goes down					
FUNCTION	OUTPUT VOLTAGE PROGRAMMABLE(PV) Note.5	Adjustment of output voltage is allowable to 50 ~ 125% of nominal output voltage Please refer to the Function Manual.					
	OUTPUT CURRENT PROGRAMMABLE(PC) Note.5	Adjustment of constant current level is allowable to 20 ~ 100% of rated current. Please refer to the Function Manual.					
	REMOTE ON/OFF CONTROL	Power ON : Short circuit		Power OFF : Open circuit			
	AUXILIARY POWER	12V @ 0.5A tolerance ±10%, ripple=150mVp-p					
	DC-OK SIGNAL	The TTL signal out, PSU turn on = 4.4 ~ 5.5V ; PSU turn off = -0.5 ~ 0.5V. Please refer to the Function Manual.					
ENVIRONMENT	WORKING TEMP.	-40 ~ +70°C (Refer to "Derating Curve")					
	WORKING HUMIDITY	20 ~ 95% RH non-condensing					
	STORAGE TEMP., HUMIDITY	-40 ~ +80°C, 10 ~ 95% RH non-condensing					
	TEMP. COEFFICIENT	±0.03%/°C (0 ~ 50°C)					
	VIBRATION	20 ~ 500Hz, 10G 12min./1cycle, period for 72min. each along X, Y, Z axes					
SAFETY & EMC (Note.7)	SAFETY STANDARDS	UL62368-1,TUV BS EN/EN62368-1, EAC TP TC 004 approved; design refer to BS EN/EN61558-1, BS EN/EN60335-1(by request)					
	WITHSTAND VOLTAGE	I/P-O/P:3KVAC I/P-FG:2KVAC O/P-FG:1.25KVAC					
	ISOLATION RESISTANCE	I/P-O/P, I/P-FG,O/P-FG:100M Ohms/500VDC/25°C / 70%RH					
	EMC EMISSION	Parameter	Standard		Test Level / Note		
		Conducted	BS EN/EN55032 (CISPR32)		Class B		
		Radiated	BS EN/EN55032 (CISPR32)		Class B		
		Harmonic Current	BS EN/EN61000-3-2		Class A		
		Voltage Flicker	BS EN/EN61000-3-3		-----		
	EMC IMMUNITY	BS EN/EN55024 , BS EN/EN61000-6-2					
		Parameter	Standard		Test Level / Note		
		ESD	BS EN/EN61000-4-2		Level 3, 8KV air ; Level 2, 4KV contact		
		Radiated	BS EN/EN61000-4-3		Level 3		
		EFT / Burst	BS EN/EN61000-4-4		Level 3		
		Surge	BS EN/EN61000-6-2		2KV/Line-Line 4KV/Line-Earth		
		Conducted	BS EN/EN61000-4-6		Level 3		
Magnetic Field		BS EN/EN61000-4-8		Level 4			
Voltage Dips and Interruptions		BS EN/EN61000-4-11		>95% dip 0.5 periods, 30% dip 25 periods, >95% interruptions 250 periods			
OTHERS	MTBF	197.9K hrs min. Telcordia SR-332 (Bellcore) ; 52.32K hrs min. MIL-HDBK-217F (25°C)					
	DIMENSION	310*144*48.5mm (L*W*H)					
	PACKING	4Kg;4pcs/17Kg/1.04CUFT					
NOTE	1. All parameters NOT specially mentioned are measured at 230VAC input, rated load and 25°C of ambient temperature. 2. Ripple & noise are measured at 20MHz of bandwidth by using a 12" twisted pair-wire terminated with a 0.1uf & 47uf parallel capacitor. 3. Tolerance includes set up tolerance, line regulation and load regulation. 4. Derating may be needed under low input voltages. Please check the derating curve for more details. 5. PV/PC functions when users do not use SVR. 6. In power mode: When O/P voltage is below < 80% of Vset for 5 sec. the unit will shut down afterwards. 7. The power supply is considered a component which will be installed into a final equipment. All the EMC tests are been executed by mounting the unit on a 720mm*360mm metal plate with 1mm of thickness. The final equipment must be re-confirmed that it still meets EMC directives. For guidance on how to perform these EMC tests, please refer to "EMI testing of component power supplies." (as available on http://www.meanwell.com) 8. The ambient temperature derating of 3.5°C/1000m with fanless models and of 5°C/1000m with fan models for operating altitude higher than 2000m(6500ft). ※ Product Liability Disclaimer : For detailed information, please refer to https://www.meanwell.com/serviceDisclaimer.aspx						



**SPECIFICATION FOR CHARGER (Option function)**

MODEL		HEP-1000-24 <input type="checkbox"/>	HEP-1000-48 <input type="checkbox"/>	HEP-1000-100 <input type="checkbox"/>	
OUTPUT	BOOST CHARGE VOLTAGE V <sub>boost</sub>	28.8V	57.6V	115.2V	
	FLOAT CHARGE VOLTAGE V <sub>float</sub>	27.6V	55.2V	110.4V	
	RECOMMENDED BATTERY CAPACITY (AMP HOURS)(Note 2)	120 ~ 350AH	60 ~ 175AH	30 ~ 85AH	
	BATTERY TYPE	Open & Sealed Lead Acid			
	OUTPUT CURRENT	35A	17.5A	8.7A	
INPUT	VOLTAGE RANGE <small>Note 3</small>	90 ~ 305VAC 250 ~ 431VDC			
	FREQUENCY RANGE	47 ~ 63Hz			
	POWER FACTOR (Typ.)	PF>0.99/115VAC, PF>0.95/230VAC, PF>0.93/277VAC at full load			
	EFFICIENCY (Typ.)	95%	96%	96%	
	AC CURRENT (Typ.)	10.1A / 115VAC	5.3A / 230VAC	4.5A / 277VAC	
	INRUSH CURRENT(Typ.)	Cold start 40A at 230VAC			
	LEAKAGE CURRENT	<0.75mA / 240VAC			
PROTECTION	SHORT CIRCUIT	Constant current limiting, unit will shutdown after 5 sec, re-power on to recover.			
	OVER VOLTAGE	30 ~ 35V	60 ~ 70V	125 ~ 145V	
	OVER TEMPERATURE	Protection type :Shut down O/P voltage, recovers automatically after temperature goes down			
FUNCTION	REMOTE ON/OFF CONTROL	Power ON : Short circuit Power OFF : Open circuit			
	AUXILIARY POWER	12V @ 0.5A tolerance ±10%, ripple=150mVp-p			
	DC-OK SIGNAL	The TTL signal out, PSU turn on = 4.4 ~ 5.5V ; PSU turn off = -0.5 ~ 0.5V. Please refer to the Function Manual.			
ENVIRONMENT	WORKING TEMP.	-40 ~ +70°C (Refer to "Derating Curve")			
	WORKING HUMIDITY	20 ~ 95% RH non-condensing			
	STORAGE TEMP., HUMIDITY	-40 ~ +80°C, 10 ~ 95% RH non-condensing			
	TEMP. COEFFICIENT	±0.03%/°C (0 ~ 50°C)			
	VIBRATION	20 ~ 500Hz, 10G 12min./1cycle, period for 72min. each along X, Y, Z axes			
SAFETY & EMC (Note.5)	SAFETY STANDARDS	UL62368-1, TUV BS EN/EN62368-1, EAC TP TC 004 approved; design refer to BS EN/EN61558-1, BS EN/EN60335-1 (by request)			
	WITHSTAND VOLTAGE	I/P-O/P:3KVAC I/P-FG:2KVAC O/P-FG:1.25KVAC			
	ISOLATION RESISTANCE	I/P-O/P, I/P-FG, O/P-FG:100M Ohms/500VDC/25°C / 70%RH			
	EMC EMISSION	Parameter	Standard	Test Level / Note	
		Conducted	BS EN/EN55032 (CISPR32)	Class B	
		Radiated	BS EN/EN55032 (CISPR32)	Class A	
		Harmonic Current	BS EN/EN61000-3-2	Class A	
		Voltage Flicker	BS EN/EN61000-3-3	----	
	EMC IMMUNITY	BS EN/EN55024 , BS EN/EN61000-6-2			
		Parameter	Standard	Test Level / Note	
ESD		BS EN/EN61000-4-2	Level 3, 8KV air ; Level 2, 4KV contact		
Radiated		BS EN/EN61000-4-3	Level 3		
EFT / Burst		BS EN/EN61000-4-4	Level 3		
Surge		BS EN/EN61000-6-2	2KV/Line-Line 4KV/Line-Earth		
Conducted		BS EN/EN61000-4-6	Level 3		
Magnetic Field		BS EN/EN61000-4-8	Level 4		
Voltage Dips and Interruptions	BS EN/EN61000-4-11	>95% dip 0.5 periods, 30% dip 25 periods, >95% interruptions 250 periods			
OTHERS	MTBF	197.9K hrs min. Telcordia SR-332 (Bellcore) ; 52.32K hrs min. MIL-HDBK-217F (25°C)			
	DIMENSION	310*144*48.5mm (L*W*H)			
	PACKING	4Kg;4pcs/17Kg/1.04CUFT			
NOTE	<ol style="list-style-type: none"> <li>All parameters NOT specially mentioned are measured at 230VAC input, rated load and 25°C of ambient temperature.</li> <li>This is Mean Well's suggested range. Please consult your battery manufacturer for their suggestions about maximum charging current limitation.</li> <li>Derating may be needed under low input voltages. Please check the derating curve for more details.</li> <li>In charge mode: When O/P voltage &lt; 67% of Vset for 5 sec. the unit will shut down afterwards.</li> <li>The power supply is considered a component which will be installed into a final equipment. All the EMC tests are been executed by mounting the unit on a 720mm*360mm metal plate with 1mm of thickness. The final equipment must be re-confirmed that it still meets EMC directives. For guidance on how to perform these EMC tests, please refer to "EMI testing of component power supplies." (as available on <a href="http://www.meanwell.com">http://www.meanwell.com</a>)</li> <li>The ambient temperature derating of 3.5°C/1000m with fanless models and of 5°C/1000m with fan models for operating altitude higher than 2000m(6500ft).</li> </ol> ※ Product Liability Disclaimer : For detailed information, please refer to <a href="https://www.meanwell.com/serviceDisclaimer.aspx">https://www.meanwell.com/serviceDisclaimer.aspx</a>				

## ■ BLOCK DIAGRAM

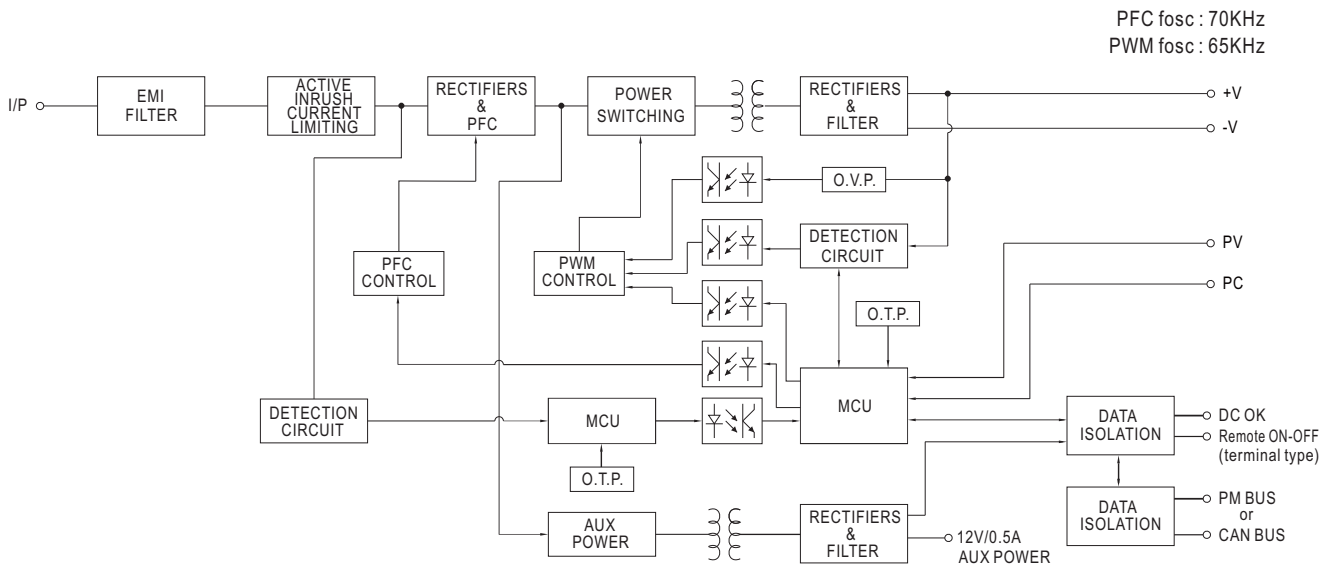

## ■ DERATING CURVE

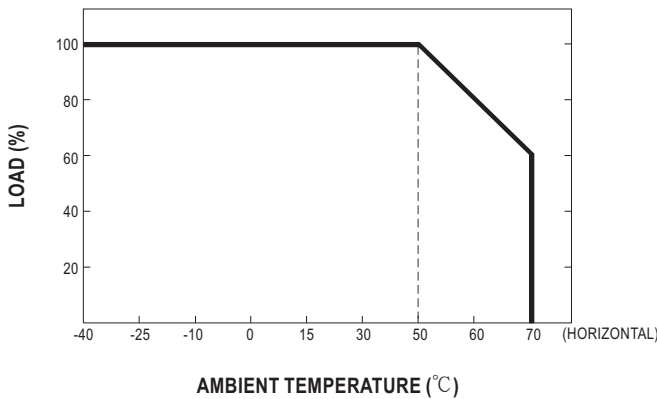

## ■ STATIC CHARACTERISTICS

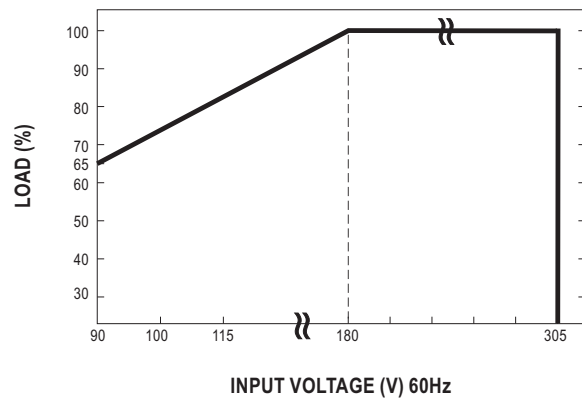

※ For 100V model charging mode, output current is 20% rated min. when operating temperature at -40°C, and can reach 100% above -30°C.

## ■ TABLE OF FUNCTION

I/O TYPE	Function type	Power Supply Function	Charging Function	PV/PC Programmable	PMBus Protocol	CANBus Protocol	LED Indicator	Remote On/Off	DC-OK Signal	Temperature Compensation	12V/0.5A Aux. output
Terminal type	Blank	V(default)	V	V	V		V	V	V	V	V
	CAN	V(default)	V	V		V	V	V	V	V	V
Wiring type	Blank	V		V					V		V
	PM	V			V				V		V
	CAN	V				V			V		V
	CPM		V		V				V	V	V
	CCAN		V			V			V	V	V

## FUNCTION MANUAL

### 1. Charging Curve (For charger type or setting HEP-1000 to charger mode)

- ※ By default, the HEP-1000 operates in power supply mode, and it can be configured to charger mode by PMBus, CANBus, or SBP-001.
- ※ By factory default, this charger performs the default curve which can be programmed via PMBus and CANBus.
- ※ To accommodate the parameters of the charging curve, SBP-001, the smart battery charging programmer designed by MEAN WELL, and a personal computer are needed. Please contact MEAN WELL for details.

#### ※ 2 stage charging curve

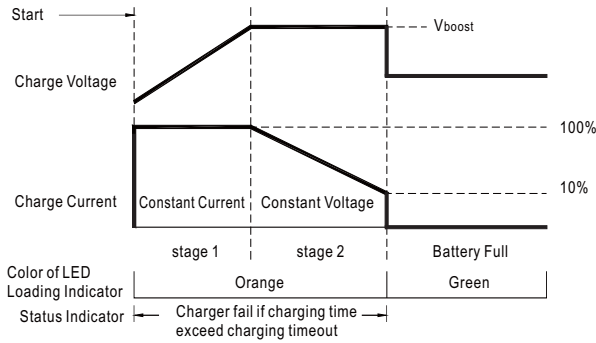

State	24	48	100
Constant Current	35A	17.5A	8.7A
Vboost	28.8V	57.6V	115.2V

◎ Suitable for lead-acid batteries (flooded, Gel and AGM) and Li-ion batteries (lithium iron and lithium manganese).

#### ※ 3 stage charging curve (default)

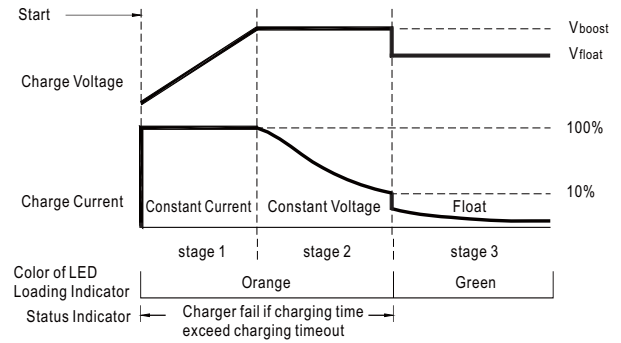

State	24	48	100
Constant Current	35A	17.5A	8.7A
Vboost	28.8V	57.6V	115.2V
Vfloat	27.6V	55.2V	110.4V

◎ Suitable for lead-acid batteries (flooded, Gel and AGM) and Li-ion batteries (lithium iron and lithium manganese).

### 2. Front Panel LED Indicators & Corresponding Signal at Function Pins (Terminal type)

LED	Description
● Green	Float (stage 3)
● Orange	Charging (stage 1 or stage 2)
● Red	Abnormal status (OTP, OLP, Charging timeout.)
● Red (Flashing)	The LED will flash with the red light when the internal temperature reaches 95°C; under this condition, the unit still operates normally without entering OTP. (In the meantime, an alarm signal will be sent out through the PMBus interface.)

### 3. Output Voltage Programming (or, PV / remote voltage programming / remote adjust / margin programming / dynamic voltage trim)

- ※ In addition to the adjustment via the built-in potentiometer, the output voltage can be trimmed by applying EXTERNAL VOLTAGE. (For Blank type of Terminal and wiring)

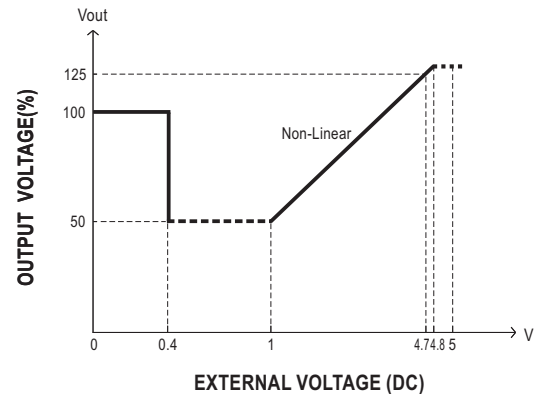
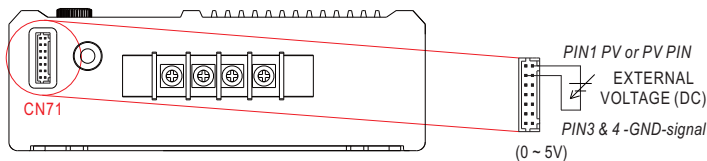

#### 4. Output Current Programming (or, PC / remote current programming / dynamic current trim)

※ The output current can be trimmed to 20~100% of the rated current by applying EXTERNAL VOLTAGE.  
 (For Blank type of Terminal and wiring)

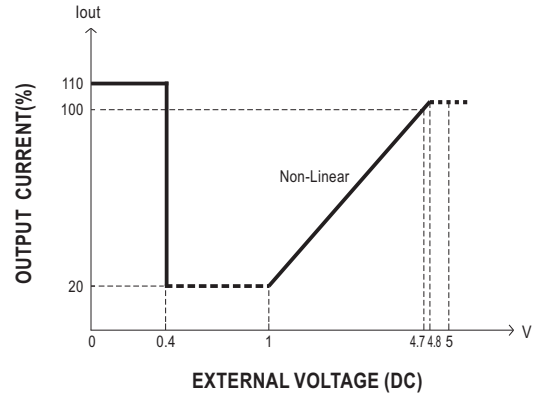
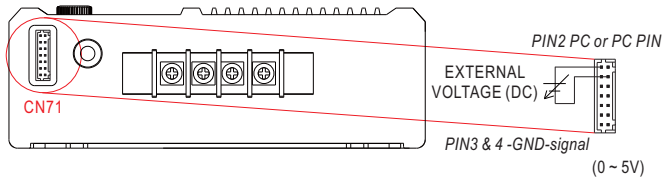

⊙ When O/P voltage is below 80% of Vset for 5 sec, the unit will shut down afterwards, re-power on to recover.

#### 5. Remote ON-OFF Control (Terminal type)

The power supply can be turned ON/OFF individually or along with other units in parallel by using the "Remote ON-OFF" function.

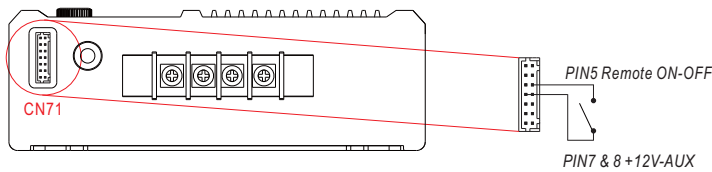

Remote ON-OFF	Power Supply Status
Short circuit	ON
Open circuit	OFF

#### 6. DC-OK Signal

DC-OK signal is a TTL level signal. The maximum source current is 10mA and the maximum external voltage is 5.5V.

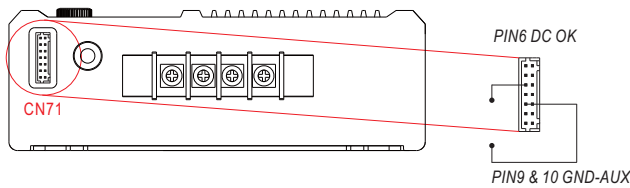

DC-OK signal	Power Supply Status
"High" >4.4~5.5V	ON
"Low" <-0.5~0.5V	OFF

#### 7. Temperature Compensation

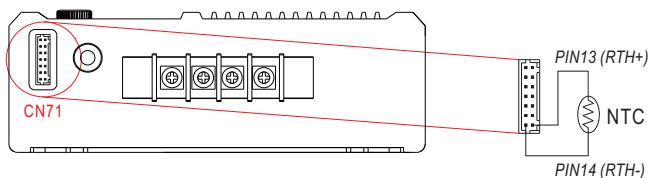

- ⊙ To exploit the temperature compensation function, please attach the temperature sensor, NTC, which is enclosed with the charger, to the battery or the battery's vicinity.
- ⊙ The charger is able to work normally without the NTC.

#### 8. PMBus Communication Interface

HEP-1000 supports PMBus Rev. 1.1 with maximum 100KHz bus speed, allowing information reading, status monitoring, output trimming, etc. For details, please refer to the User's Manual.

## MECHANICAL SPECIFICATION

Case No.228F

Unit:mm

※Blank-Type (Terminal type)

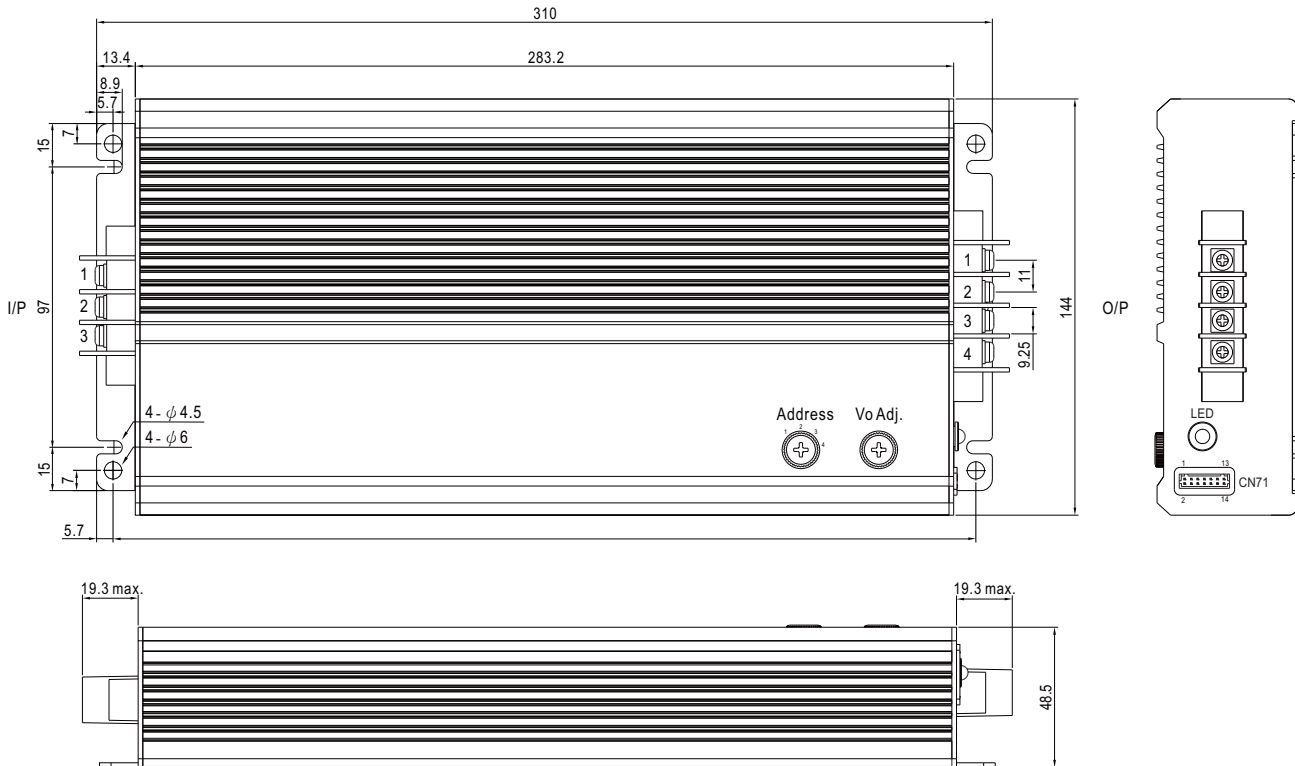

- ※ Output voltage current level can be adjusted through internal potentiometer.(Vo Adj.)  
(Can access by removing the rubber stopper on the case.)
- ※ PMBus interface address selection.(Address)

AC Input Terminal Pin No. Assignment

Pin No.	Assignment
1	FG (⊖)
2	AC/L
3	AC/N

DC Output Terminal Pin No. Assignment

Pin No.	Assignment
1,2	-V
3,4	+V

※Control Pin No. Assignment(CN71) : JST S14B-PHDKS-B or equivalent

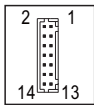

Mating Housing	JST PHDR-14VS or equivalent
Terminal	JST SPHD-001T-P0.5 or equivalent

Pin No.	Function	Description
1	PV	Connection for output voltage programming.(Note1)
2	PC	Connection for constant current level programming.(Note.1)
3,4	GND (Signal)	Negative output voltage signal.
5	Remote ON-OFF	The unit can turn the output ON/OFF by dry contact between Remote ON/OFF and +12-AUX.(Note.2) Short (10.8 ~ 13.2V) : Power ON ; Open(0 ~ 0.5V) : Power OFF ; The maximum input voltage is 13.2V
6	DC-OK	Low (-0.5 ~ 0.5V) : When $V_{out} \leq 77\% \pm 6\%$ at power mode. $V_{out} \leq 66\% \pm 6\%$ at charger mode. High (4.4 ~ 5.5V) : When $V_{out} \geq 80\% \pm 6\%$ at power mode. $V_{out} \geq 67\% \pm 6\%$ at charger mode. The maximum sourcing current is 10mA and only for output. (Note.2)
7,8	+12V-AUX	Auxiliary voltage output, 10.8~13.2V, referenced to GND-AUX (pin9 & 10). The maximum load current is 0.5A. This output is not controlled by "Remote ON-OFF".
9,10	GND-AUX	Auxiliary voltage output GND. The signal return is isolated from the output terminals (+V & -V).
11	SDA	For PMBus model: Serial Data used in the PMBus interface. (Note.2)
	CANH	For CANBus model: Data line used in CANBus interface. (Note.2)
12	SCL	For PMBus model: Serial Clock used in the PMBus interface. (Note.2)
	CANL	For CANBus model: Data line used in CANBus interface. (Note.2)
13	RTH+	Temperature sensor(NTC, 5KOhm) comes along with the charger can be connected to the unit to allow temperature compensation of the charging voltage.
14	RTH-	

Note1: Non-isolated signal, referenced to [GND(signal)].

Note2: Isolated signal, referenced to GND-AUX.

※W-Type (Wiring type)

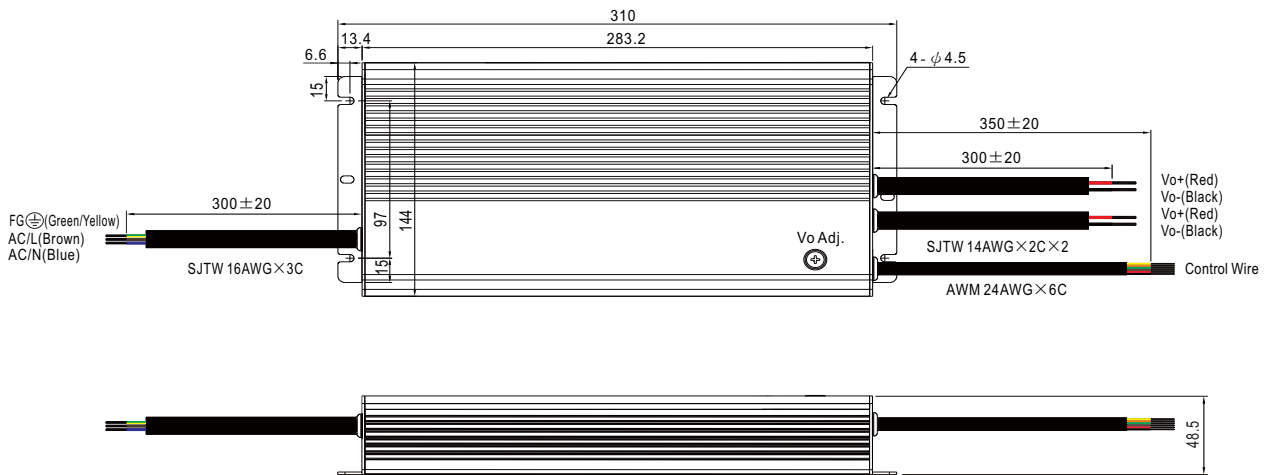

※ Output voltage current level can be adjusted through internal potentiometer.  
(Can access by removing the rubber stopper on the case.)

※ Control Wire Assignment : (AWM 24AWG×6C)

Color	Function	Description
Yellow	PV	Connection for output voltage programming.(Note1)
Orange	PC	Connection for constant current level programming.(Note.1)
Green	GND (Signal)	Negative output voltage signal.(PV/PC GND)
Brown	DC-OK	Low (0 ~ 0.5V) : When $V_{out} \leq 77\% \pm 6\%$ at power mode. $V_{out} \leq 66\% \pm 6\%$ at charger mode. High (4.4 ~ 5.5V) : When $V_{out} \geq 80\% \pm 6\%$ at power mode. $V_{out} \geq 67\% \pm 6\%$ at charger mode. The maximum sourcing current is 10mA and only for output.(Note.2)
Red	+12V-AUX	Auxiliary voltage output, 10.8~13.2V, referenced to GND-AUX. The maximum load current is 0.5A.
Black	GND-AUX	Auxiliary voltage output GND. The signal return is isolated from the output terminals (+V & -V).

Note1: Non-isolated signal, referenced to [GND(signal)].

Note2: Isolated signal, referenced to GND-AUX (GND for CANBus and PMBus protocol).

※W-Type (Wiring type with charger)

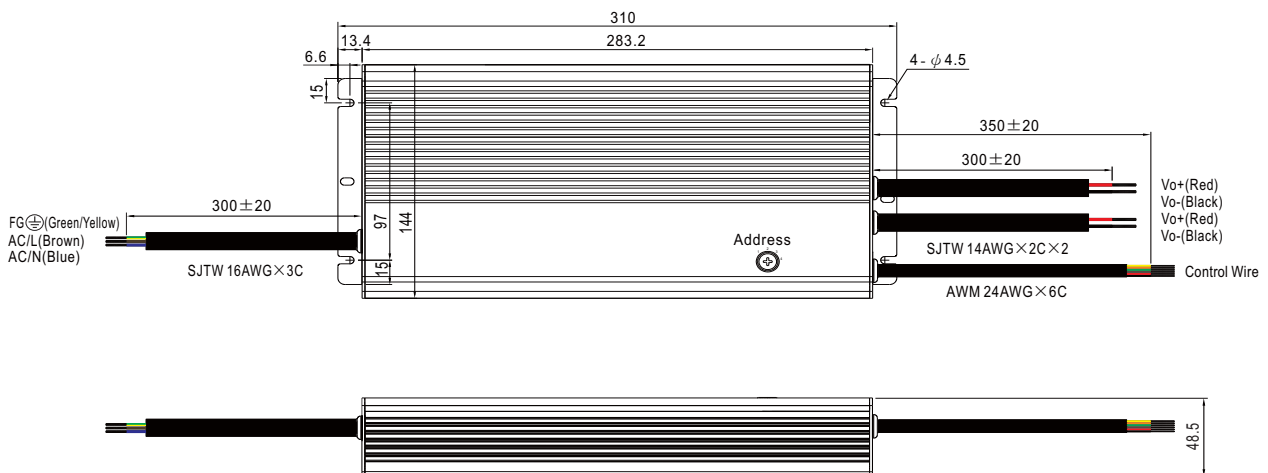

※ Output voltage current level can be adjusted through internal potentiometer.  
(Can access by removing the rubber stopper on the case.)

※ Control Wire Assignment : (AWM 24AWG×6C)

Color	Function	Description
Yellow	SDA	For PMBus model: Serial Data used in the PMBus interface. (Note.1)
	CANH	For CANBus model: Data line used in CANBus interface. (Note.1)
Orange	SCL	For PMBus model: Serial Clock used in the PMBus interface. (Note.1)
	CANL	For CANBus model: Data line used in CANBus interface. (Note.1)
Green	RTH-	Temperature sensor(NTC, 5KOhm) comes along with the charger can be connected to the unit to allow temperature compensation of the charging voltage.
Brown	RTH+	
Red	+12V-AUX	Auxiliary voltage output, 10.8~13.2V, referenced to GND-AUX. The maximum load current is 0.5A.
Black	GND-AUX	Auxiliary voltage output GND. The signal return is isolated from the output terminals (+V & -V).

Note1: Isolated signal, referenced to GND-AUX.



※W-Type (Wiring of WPM/WCAN)

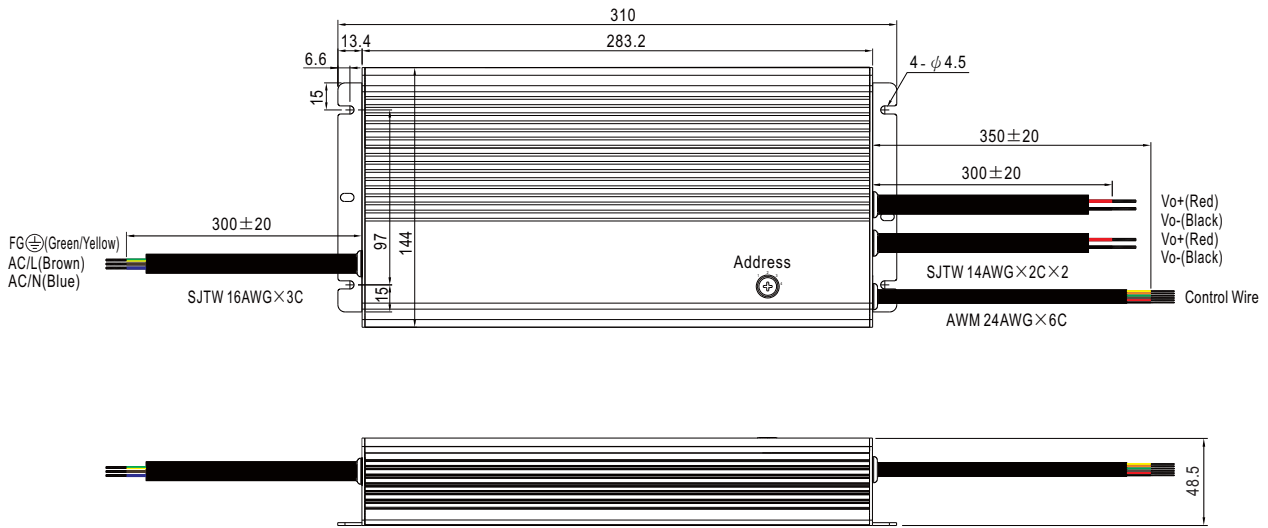

※ Output voltage current level can be adjusted through internal potentiometer.  
(Can access by removing the rubber stopper on the case.)

※ Control Wire Assignment : (AWM 24AWG x 6C)

Color	Function	Description
Yellow	SDA	For PMBus model: Serial Data used in the PMBus interface. (Note.1)
	CANH	For CANBus model: Data line used in CANBus interface. (Note.1)
Orange	SCL	For PMBus model: Serial Clock used in the PMBus interface. (Note.1)
	CANL	For CANBus model: Data line used in CANBus interface. (Note.1)
Green	GND (Signal)	Negative output voltage signal.(PV/PC GND)
Brown	DC-OK	Low (0 ~ 0.5V) : When $V_{out} \leq 77\% \pm 6\%$ at power mode. $V_{out} \leq 66\% \pm 6\%$ at charger mode.
		High (4.4 ~ 5.5V) : When $V_{out} \geq 80\% \pm 6\%$ at power mode. $V_{out} \geq 67\% \pm 6\%$ at charger mode. The maximum sourcing current is 10mA and only for output.(Note.1)
Red	+12V-AUX	Auxiliary voltage output, 10.8~13.2V, referenced to GND-AUX. The maximum load current is 0.5A.
Black	GND-AUX	Auxiliary voltage output GND. The signal return is isolated from the output terminals (+V & -V).

Note1: Isolated signal, referenced to GND-AUX.

## ■ INSTALLATION MANUAL

Please refer to : <http://www.meanwell.com/manual.html>